

LIMITED USE

WEIGHT: 99 lbs

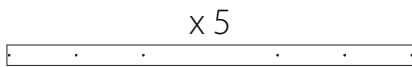

Torx 20
⊕ x 30

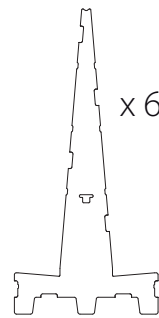

EXTENSIVE USE

WEIGHT: 121 lbs

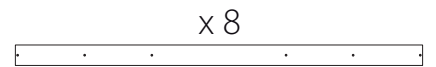

Torx 20
⊕ x 48

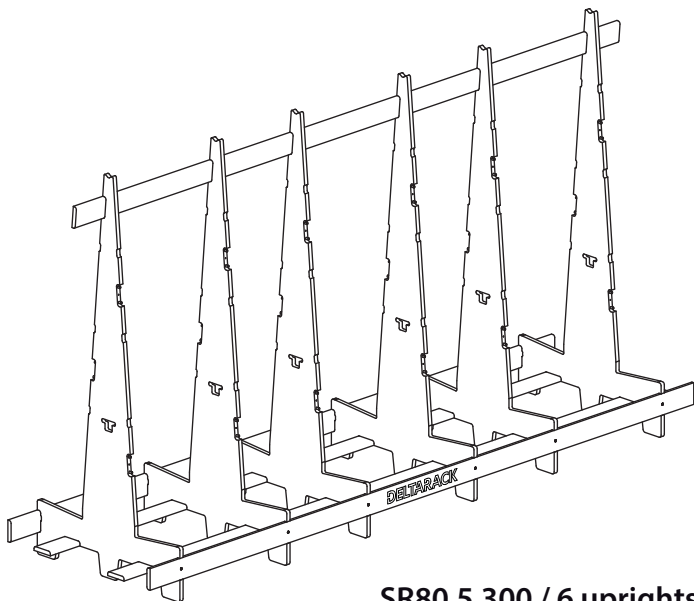

SR80.5.300 / 6 uprights

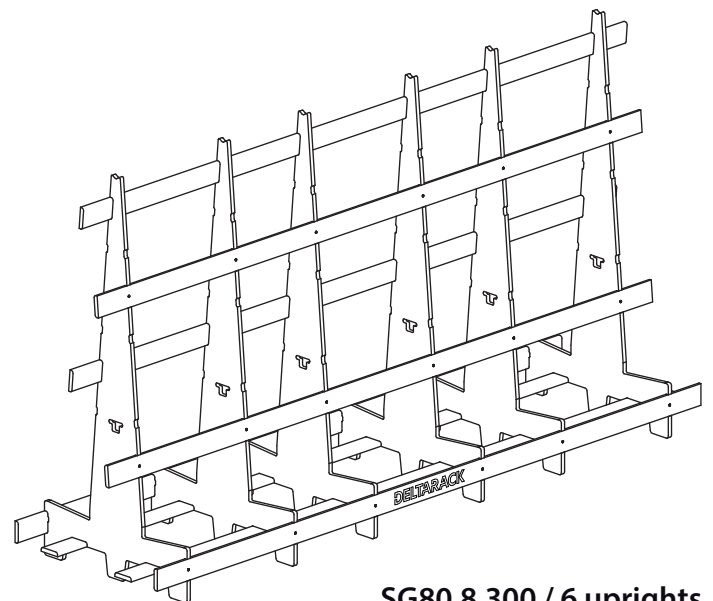

SG80.8.300 / 6 uprights

Optional
Wheelboard kit: WB80.60



(*) Load needs to be equally distributed over all vertical uprights of the rack