

**LIMITED USE**

WEIGHT: 71 lbs

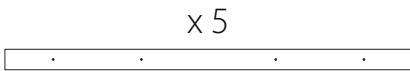

Torx 20  
⊕ x 20

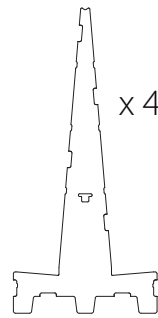

**EXTENSIVE USE**

WEIGHT: 88 lbs

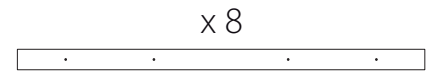

Torx 20  
⊕ x 32

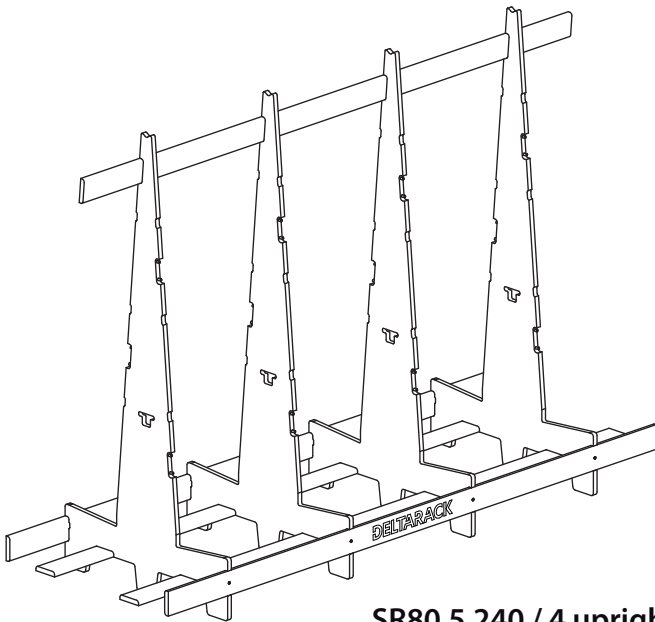

**SR80.5.240 / 4 uprights**

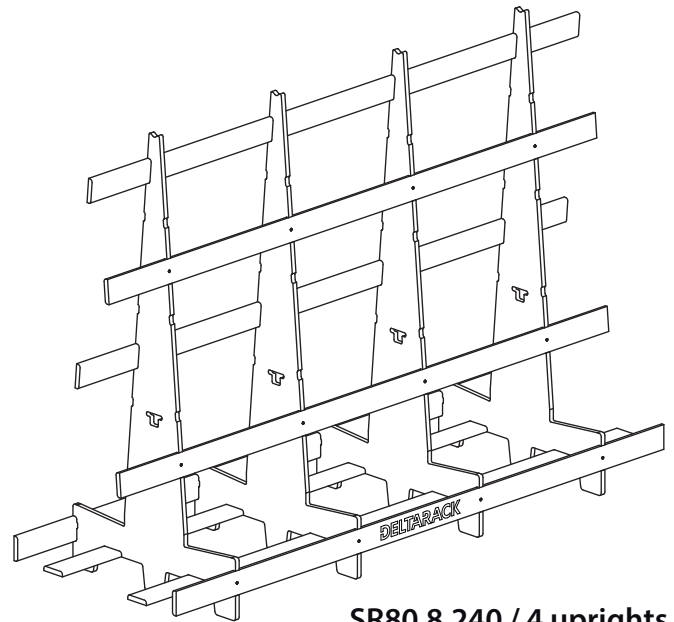

**SR80.8.240 / 4 uprights**

Optional  
Wheelboard kit: WB80.60



(\*) Load needs to be equally distributed over all vertical uprights of the rack