

**LIMITED USE**

WEIGHT: 99 lbs

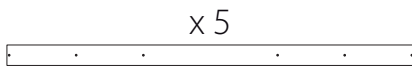

Torx 20  
⊕ x 30

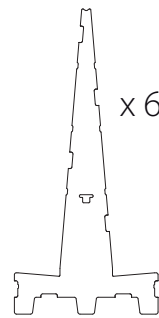

**EXTENSIVE USE**

WEIGHT: 121 lbs

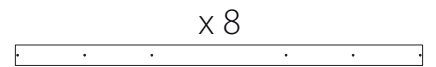

Torx 20  
⊕ x 48

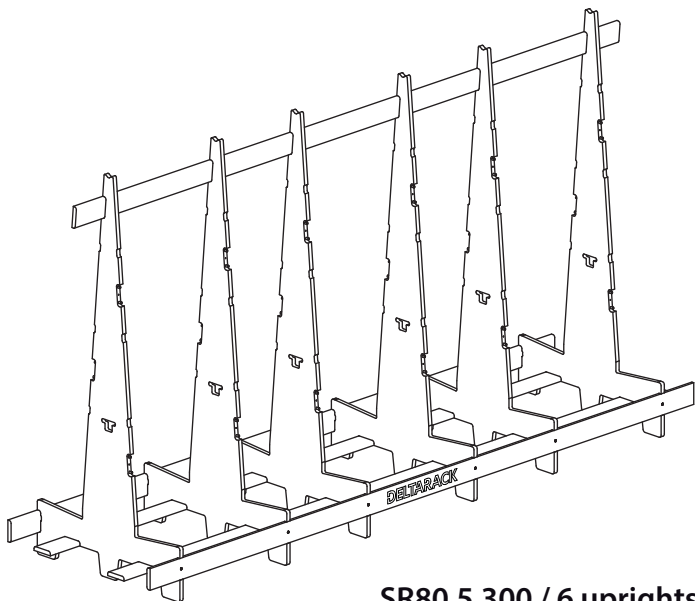

**SR80.5.300 / 6 uprights**

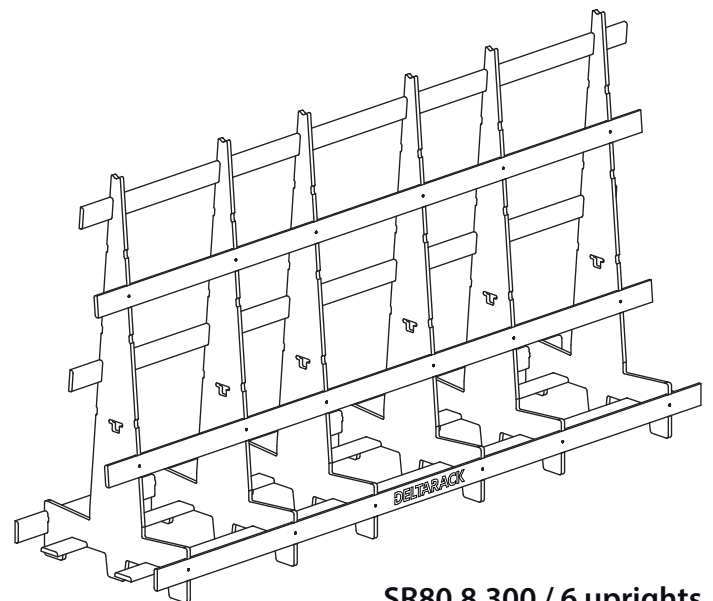

**SR80.8.300 / 6 uprights**

Optional  
Wheelboard kit: WB80.60



(\* ) Load needs to be equally distributed over all vertical uprights of the rack